

6G: DESIGNING A SUSTAINABLE WAY FORWARD

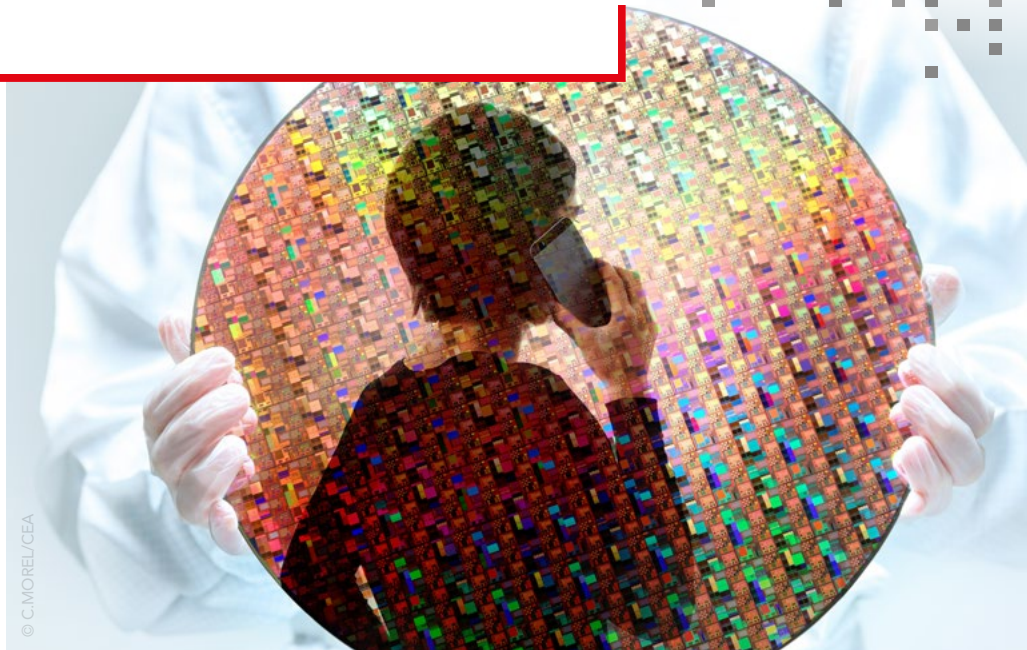

© C. MOREL/CEA

Press Contact:

Camille Giroud
T. +33 438 783 713
camille.giroud@cea.fr

CEA-Leti, technology research institute
Commissariat à l'énergie atomique et aux énergies alternatives
Minatec Campus | 17 avenue des Martyrs
38054 Grenoble Cedex 9 | France
www.cea-leti.com

TABLE OF CONTENTS

INTRODUCTION	3
What will 6G be like?	3
What are the performance levels of 6G?	4
NEEDS IN HARDWARE TECHNOLOGIES	5
Adapting our CMOS standards to millimeter wave bands	6
LiFi – An alternative on the rise	7
Developing optimized radiofrequency systems that use less energy	8
New with 6G: The deployment of reconfigurable intelligent surfaces	10
Geolocating within 1 centimeter and without service interruption	12
IoT: Finding good coverage	14
ACADEMIC & INSTITUTIONAL PROJECTS	15

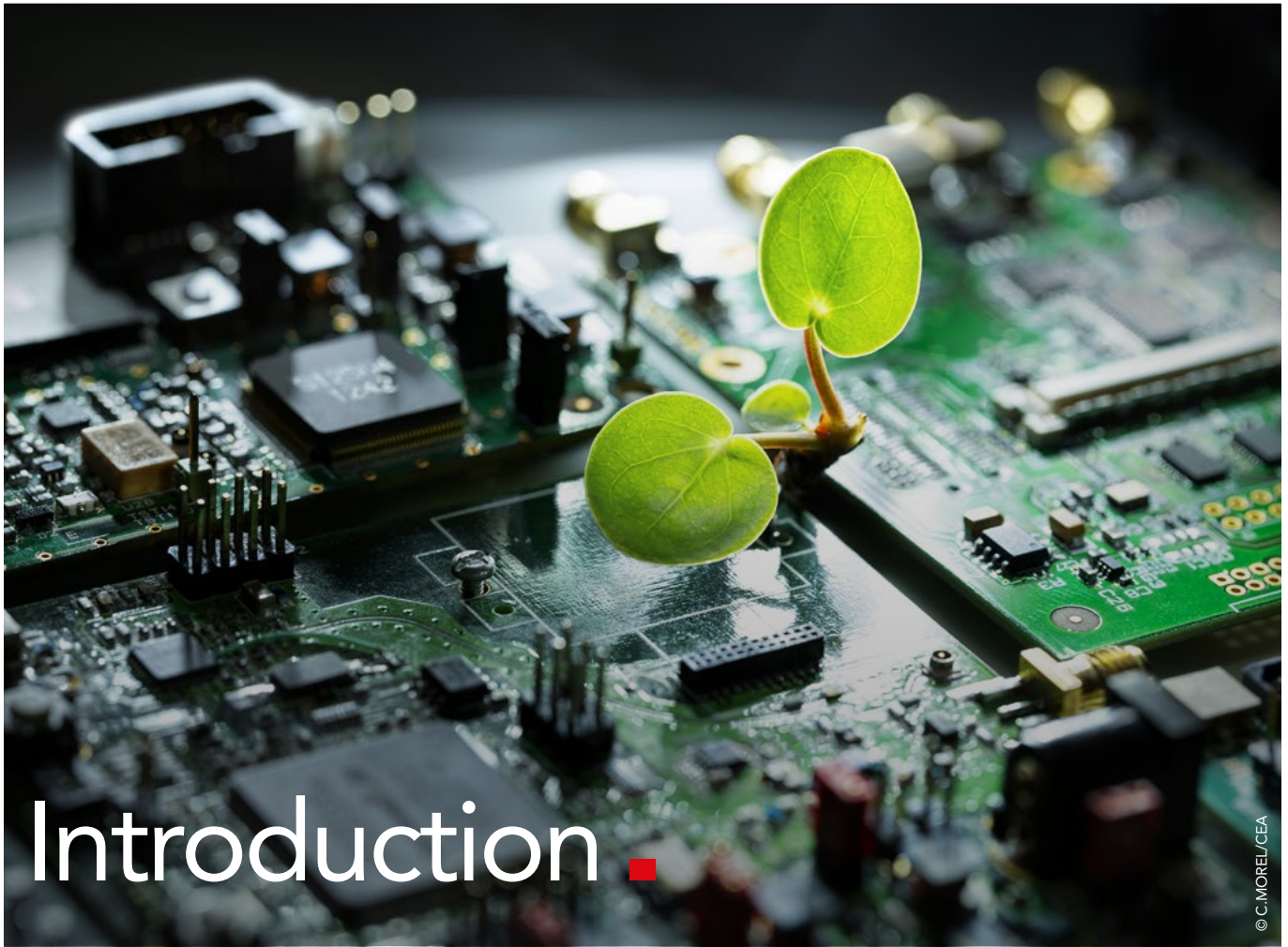

Introduction ■

With 9 billion humans connected and five times more communicating objects in the world by 2030, the deluge of data has become a real area of interest. How to keep up this pace? Is it viable? CEA-Leti is providing a global response to this environmental problem. The institute is developing edge artificial intelligence to limit data transfers to the Cloud, sometimes located thousands of miles from the user. Continuing with this approach, CEA-Leti is participating in future 6G developments.

WHAT WILL 6G BE LIKE?

While previous generations relied on the continuity of pre-existing technologies to achieve absolute performance, 6G, as viewed by CEA-Leti, aims to adopt a new approach, combining energy frugality with performance.

To improve access capacities, the researchers plan to make joint and massive use of satellite, aerial, and terrestrial platforms. In parallel, they are bolstering computing and intelligence capacities within components to improve data rates and latency while limiting energy consumption. Finally, 6G should enable new services by 2030.

WHAT ARE THE PERFORMANCE LEVELS OF 6G?

While data rate remains the key performance objective, gains will not be made at any cost. CEA-Leti aims to take society's needs and concerns into account, including sustainability criteria.

	5G+	6G
Traffic	10 Mbps/m ²	~ 1-10 Gbps/m ³
Downstream rate (Infrastructure to mobile device)	20 Gbps	1 Tbps
Upstream rate (Mobile device to infrastructure)	10 Gbps	1 Tbps
Uniformity of user experience	50 Mbps 2D everywhere	10 Gbps 3D everywhere
Latencies	Up to 1 ms max	Up to 0.1 ms max
Temporal jitter	NS	1 μs
Reliability of transmission, error rate	Up to 10 ⁻⁵	Up to 10 ⁻⁹
Energy/bit	NS	nJ/bit
Geolocalization accuracy	10 cm in 2D	1 cm in 3D

Sustainability

Through this initiative (see inset), researchers and European industrial actors share the common goal of creating a brand new generation capable of reaching sustainability objectives and limiting the impact of the massive increase in data. To achieve this, the technologies supporting previous generations must undergo profound changes. According to Jean Baptiste Doré, head of CEA-Leti's 6G program, "This is CEA-Leti's core mission. Beyond developing new lower-consumption components, it's a matter of reinventing an entire orchestration."

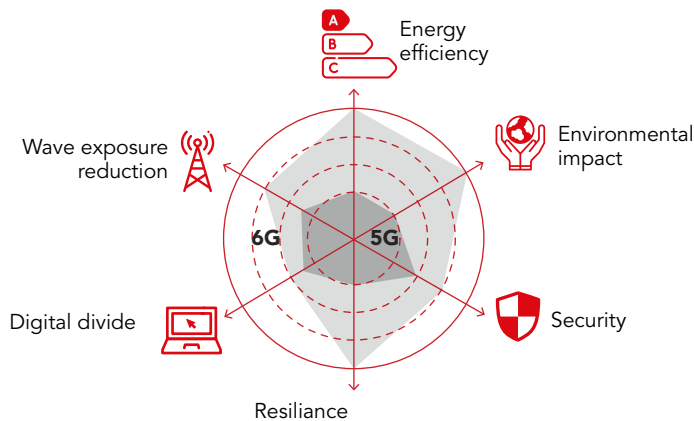

Researchers will have to increase performance while controlling or even decreasing energy use. 6G technologies must be capable of optimizing waves to point them at the user and thus avoid a vast field of emissions and considerable energy losses

NEW-6G: CEA-Leti brings together all academic and industrial actors

In February 2021, CEA-Leti announced the creation of a think tank bringing together a large proportion of European academic and industrial actors. European giants, from telecoms to foundries, not to mention research centers, responded to the call. Together, they are preparing a roadmap to meet performance and sustainability objectives and are committed to cooperating around the creation of this sixth generation.



Emilio Calvanese Strinati, head of European 6G projects and of the NEW-6G initiative at CEA-Leti



© C. MOREL/CEA

Needs in Hardware Technologies

To develop a new generation of communication systems, CEA-Leti engineers are focusing on higher frequency ranges, offering greater bandwidth and more and more efficient transmission. In continuity with 5G, 6G will rely on millimeter frequency bands beyond 100 GHz.

However, several technological challenges must be overcome:

- The propagation of waves at these frequencies becomes difficult
- Silicon-based technologies reach their limit

CEA-Leti has adopted a global approach to these challenges. First, the use of antenna arrays improves the spectral efficiency by propagating the waves in a given direction rather than haphazardly, compensating for propagation losses. In addition, the institute is studying new materials and developing new modules for bands beyond 100GHz. These modules combine microelectronic standards (CMOS) and III-V materials.

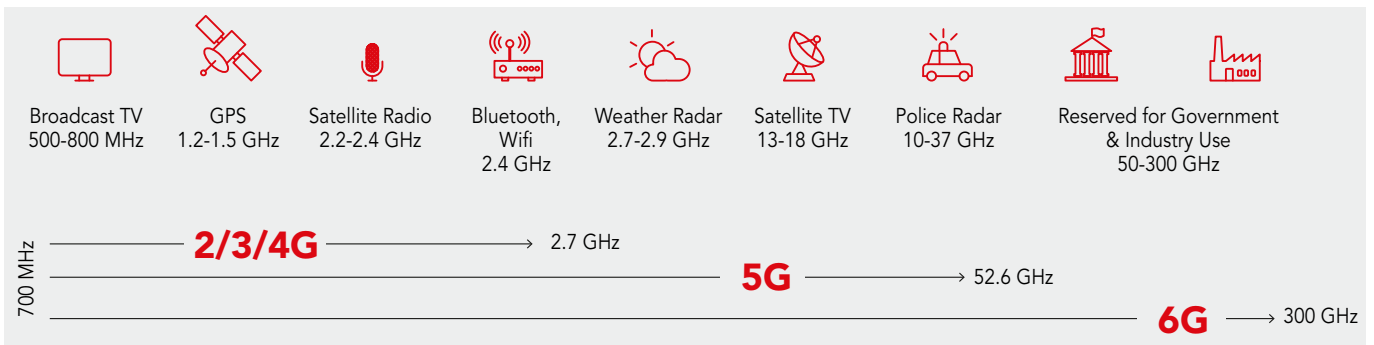

ADAPTING OUR CMOS STANDARDS TO MILLIMETER WAVE BANDS

With their high bandwidth that is unsurpassed in terms of data rates, the 6G wireless communications of the future will use millimeter waves up to 300GHz. CEA-Leti researchers are focusing on the D band, the 6G "candidate" band and boasting a spectrum from 110 GHz to 170 GHz. Because silicon technologies are currently unsuited for this band, they are trying to push back the limits.

There is a race against time to develop a new integrated module capable of meeting the high energy performance and cost requirements.

- In 2021, the institute developed a demonstrator capable of reaching 100 Gb/s featuring a great energy efficiency level.
- For device-to-device communication, CEA-Leti demonstrated that it was possible to reach a data rate of several Gbit/s by using spatial multiplexing and an energy-efficient antenna architecture.

Materials and radiofrequency performance of circuits

To improve the speed, quality, and capacities of smartphone computing, a general manufacturing process called RF-Silicon-on-Insulator (SOI) Smart Cut™, invented at CEA-Leti and transferred to SOITEC, is now being used in every smartphone. This substrate increases the radiofrequency performance of circuits and emission-reception modules. It will also be a building block for future 6G smartphones.



With CMOS technologies, we can still design systems in the lower part of the D band, but we have reached their limits. There are wave propagation losses and these losses increase with increasing frequency.



José-Luis Gonzalez Jimenez,
research director
at CEA-Leti

DEMONSTRATION

CEA-Leti has developed a first demonstrator that reaches speeds of up to 100 Gb/ s. This technology meets both high performance, low energy and low cost requirements.

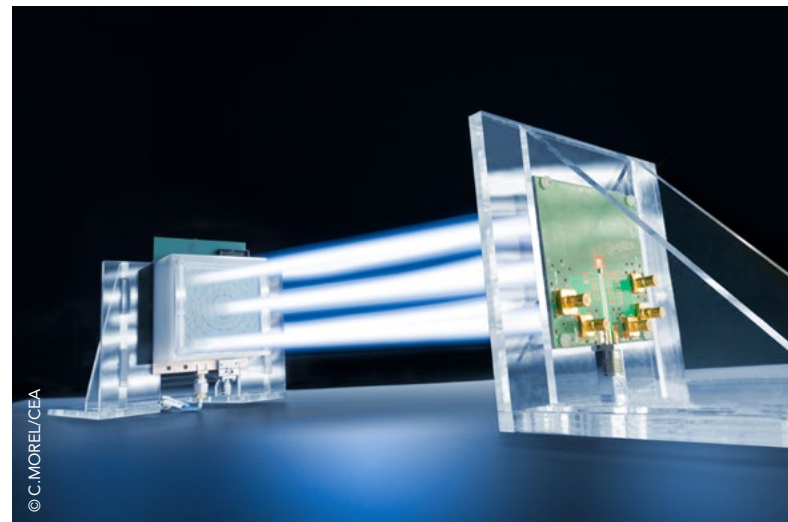

LiFi – AN ALTERNATIVE ON THE RISE

In addition to the work done on millimeter wave bands, LiFi is a relevant alternative to decongest the RF spectrum. There has recently been renewed interest in this field due to the massive influx of LED lighting and the capacity of LEDs to transmit data at high speeds. LEDs offer the following advantages:

- ultra-wide bandwidth
- no RF electromagnetic interference
- insensitive to the RF environment

Currently, commercially available LiFi systems use non-optimized LEDs for optical telecommunications. CEA-Leti researchers intend to propose new solutions to LED manufacturers, notably with the introduction of microLEDs incorporating gallium nitride (GaN) to generate more bandwidth. In 2020, the institute broke a data rate record with a 10-micron microLED doped with gallium nitride (GaN) and having a data rate of 7.7 gigabits per second. It surpassed the previous record of 5.1 gigabits per second.



DEVELOPING OPTIMIZED RADIOFREQUENCY SYSTEMS THAT USE LESS ENERGY

Antennas play a decisive role in the telecommunications sector. They emit, transmit, and receive signals that move information between connected objects (e.g. smartphones) and base stations. At CEA-Leti, the technologies developed for antennas aim to:

- optimize the reception and emission of signals
- efficiently manage signal propagation
- accurately identify the user's position

The institute draws on its silicon and radiofrequency expertise to propose components to industry for the 6G antennas of the future. For the first time in the history of telecoms, this new generation will have to combine performance with energy efficiency. The development of beam-focusing technologies is an illustration of this. In this area, CEA-Leti is working on new generations of antenna systems, including:

- integrating antennas in their environment while maximizing the efficiency to size ratio
- using new materials to make antennas more agile
- designing complex antenna systems to enable targeted beam formation

Finally, one of the wireless system components that consumes the most energy is the power amplifier. It amplifies the RF signal, making it possible to extend the range of communications. In addition to the RF power and the operating frequency, the need for linearity is a key factor in the design of power amplifiers. To meet 6G needs, CEA-Leti researchers are developing amplifiers capable of processing increasingly complex signals without signal distortion in a wide bandwidth.



Today, the average energy efficiency of power amplifiers is less than 50%. The increase in frequency along with the complexification of signals and the linearity required by 6G tend to degrade the energy performance of traditional solutions.



Alexandre Giry,
researcher
at CEA-Leti

ANECHOIC CHAMBER

CEA-Leti has one Europe's largest anechoic chambers. It helps measure antenna properties, including their electromagnetic waves.

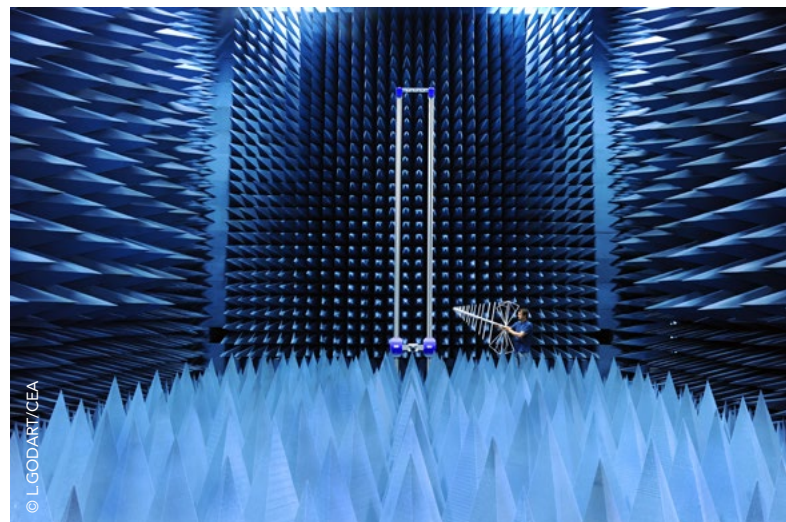



The miniaturization of these SOI-CMOS amplifiers and the introduction of new functionalities should accelerate their commercialization.

Alexandre Giry,
researcher
at CEA-Leti



To resolve to this problem, CEA-Leti researchers are developing new technologies and architectures. In particular, they are using SOI-CMOS technology, compatible with high-efficiency reconfigurable architectures. An initial SOI-CMOS module came out of the laboratory in 2021. It offers very good linearity coupled with high energy efficiency over a wide range of frequencies. Among other advantages, this new module offers good robustness and a small size through the use of advanced encapsulation techniques.

CEA-Leti also makes use of a material that has become indispensable, gallium nitride (GaN). It has the significant characteristic of limiting energy losses and compatibility with standard microelectronic technologies (CMOS) and new hybridation techniques. The co-design of power amplifiers and transistors with other materials is also under study, notably to meet the specific needs of frequency bands up to 300GHz.

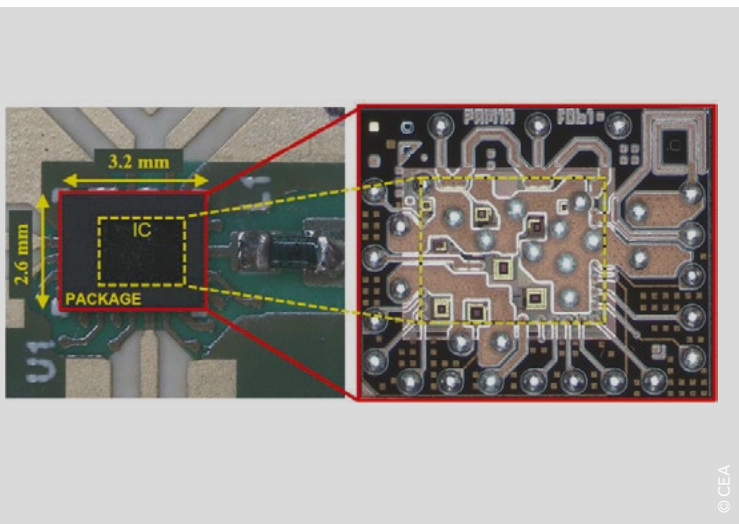

FIRST SOI-CMOS MODULE

Pioneered in 2021 by the institute, this first SOI-CMOS module operates over a wide frequency range and offers:

- high energy efficiency
- good linearity
- great robustness

NEW WITH 6G: THE DEPLOYMENT OF RECONFIGURABLE INTELLIGENT SURFACES

Reconfigurable intelligent surfaces are considered one of the most promising technologies for improving coverage, dynamically adjusting service quality, and/or reducing exposure to electromagnetic waves. Concretely, they make it possible to electronically manipulate the characteristics of the electromagnetic field. These low-cost surfaces are made up of thousands of radiating elements capable of redirecting waves containing information to the right place. They will serve as an intermediary between base stations and users.

They have three modes:

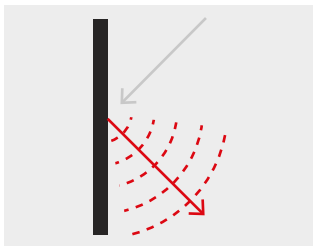

Reflective mode
e.g. acting like a mirror, to reflect the wave toward the user

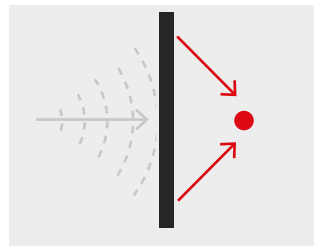

Through mode
e.g. to help millimeter waves more easily pass through buildings

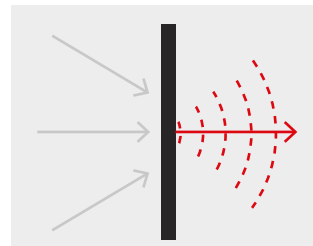

Refocalization and uniformization mode
e.g. to cover dead zones



Contrary to previous generations that sent waves haphazardly, these surfaces will make it possible to target needs. This means that for the very first time our approach is purely qualitative. And above all, these surfaces consume little energy.

Antonio Clemente,
senior expert in charge of
designing these future
surfaces, CEA-Leti

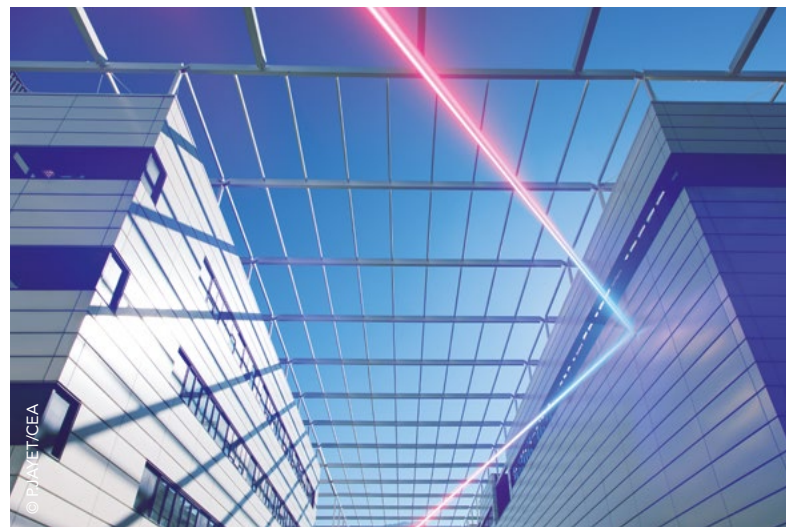



These surfaces improve localization accuracy, energy efficiency, and above all guarantee the confidentiality of communications by targeting the user as closely as possible. They are non-invasive and will be deployed in cities to improve spectral efficiency.

Emilio Calvanese Strinati, coordinator of the RISE-6G project and head of European 6G projects at CEA-Leti



CEA-Leti is recognized worldwide in the design of reconfigurable transmitter networks. It can be credited with the state of the art in various frequency bands (10-40 GHz). To make these surfaces usable, the institute is developing new systems compatible with frequencies up to 300 GHz and algorithms that decide in real time the mode to adopt (reflective, through, refocalization). Priority will be given to cities in deploying these surfaces, where there are a multitude of actors and obstacles.

Project H2020: RISE-6G

With a budget of €6.5M, CEA-Leti has been coordinating the European project RISE-6G since 2021. In partnership with industry actors such as Orange, this project aims to design and prototype these reconfigurable intelligent surfaces between now and 2023.

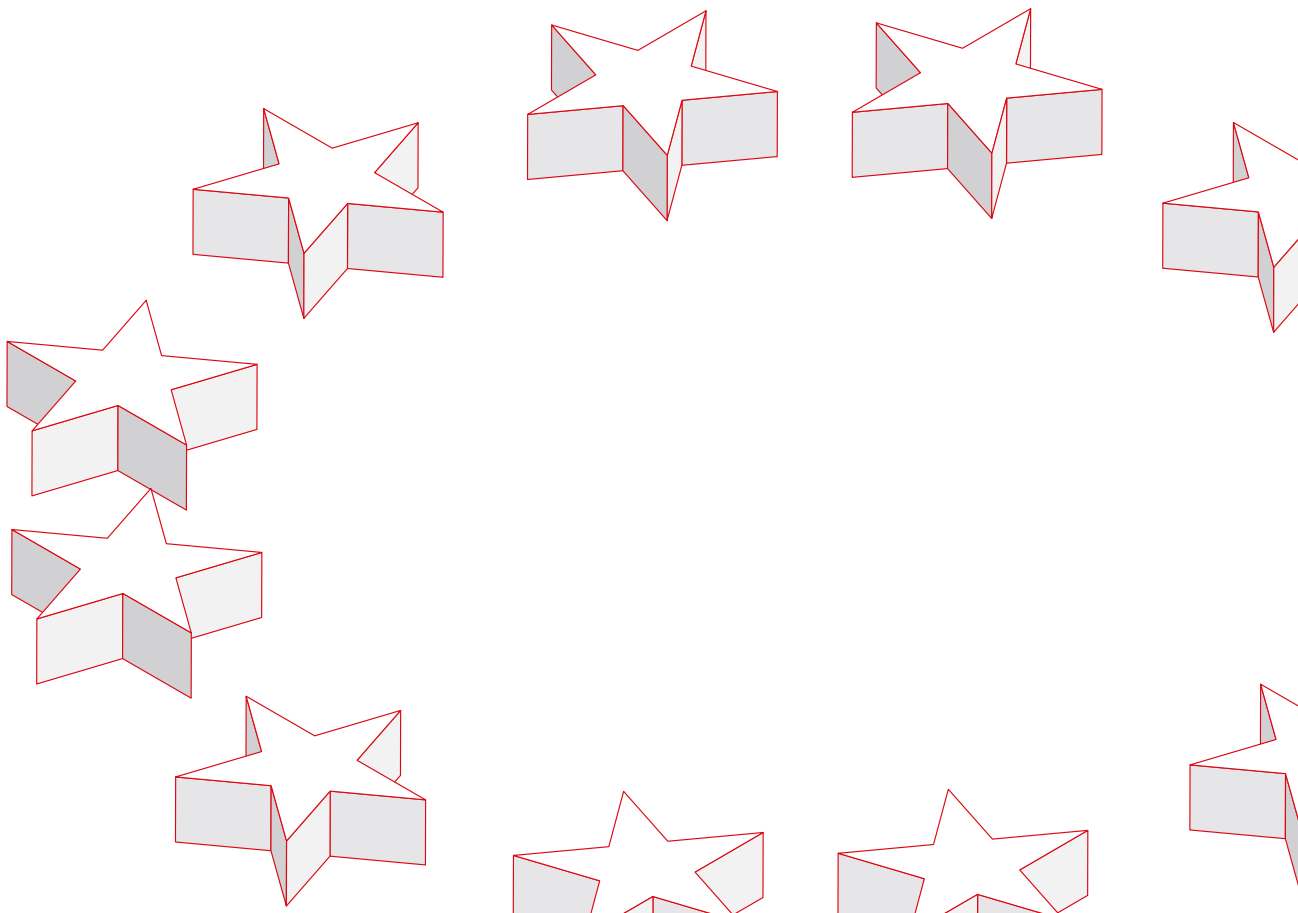

GEOLOCALIZING WITHIN 1 CENTIMETER AND WITHOUT SERVICE INTERRUPTION

Being able to accurately and reliably geolocalize users and obstacles will soon be essential for ensuring the proper operation of numerous future applications, such as self-driving cars or industry 4.0. Current GNSS technologies (an extension of GPS) do not allow reaching the degree of accuracy desired in all types of environments (e.g. inside buildings, urban canyons, tunnels, factories, underground parking garages, etc.), most often due to obstruction of the radio signal.

New tool: reconfigurable intelligent surfaces

To improve localization performance in future 6G networks, researchers can draw on the wide bands available at high frequencies (offering better spatial resolution) and can also make use of reconfigurable intelligent surfaces capable of modifying the propagation channel for:

- creating new reflections of the transmitted signal, useful in localization;
- optimizing the beams based on the mobile user's last known position;
- offering variable localization accuracy levels, depending on the context of use, users' real needs, or regulation;
- minimizing the number and emission power of base stations.



Reconfigurable surfaces offer unequalled propagation flexibility that, combined with very directive transmissions occupying a wide band of frequencies, will enable better estimation of the direction and arrival time of the radio signal, and ultimately better tracking of the mobile user.

In this way, we hope to create a virtuous circle where more and more precise localization information will make it possible to optimize the beams, for example, at the base stations or the reflective surfaces, and thus the quality of the radio links themselves.

Benoît Denis, CEA-Leti researcher specializing in localization technologies

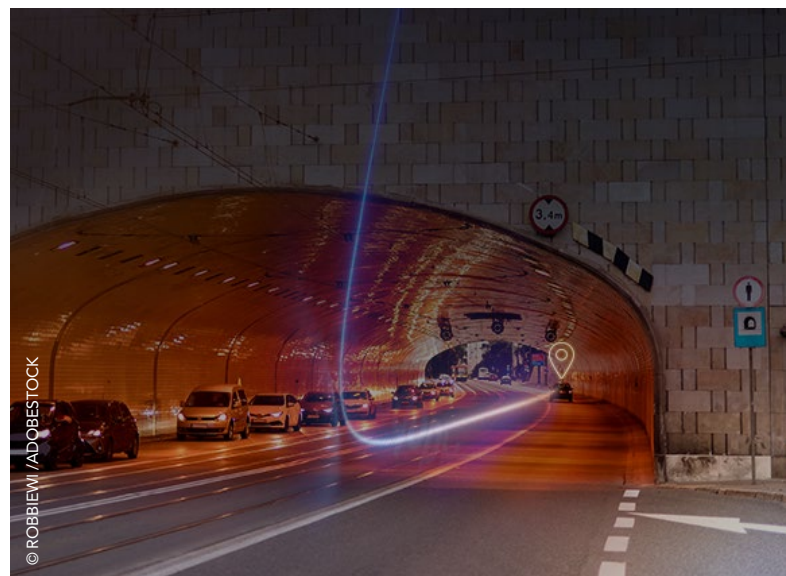



Based on satellite observations, GNSS receivers are particularly sensitive to obstacles such as tunnels and metal structures. There is also growing concern about the recent number of attacks against GNSS systems.

Christophe Villien,
researcher
at CEA-Leti



Towards greater precision, reliability and security

4G
~10 meters
2D

5G
~10 cm -1 meters
2D

6G
~1-10 cm
3D

While emerging applications will need an ultra-accurate localization service, they will also and above all need reliability. In addition to work on 6G localization, the institute is also developing hybrid localization systems which, after processing and aggregation of data from various complementary technologies (radio or non-radio), make record-breaking accuracy possible, while at the same time protecting against cyberattacks.

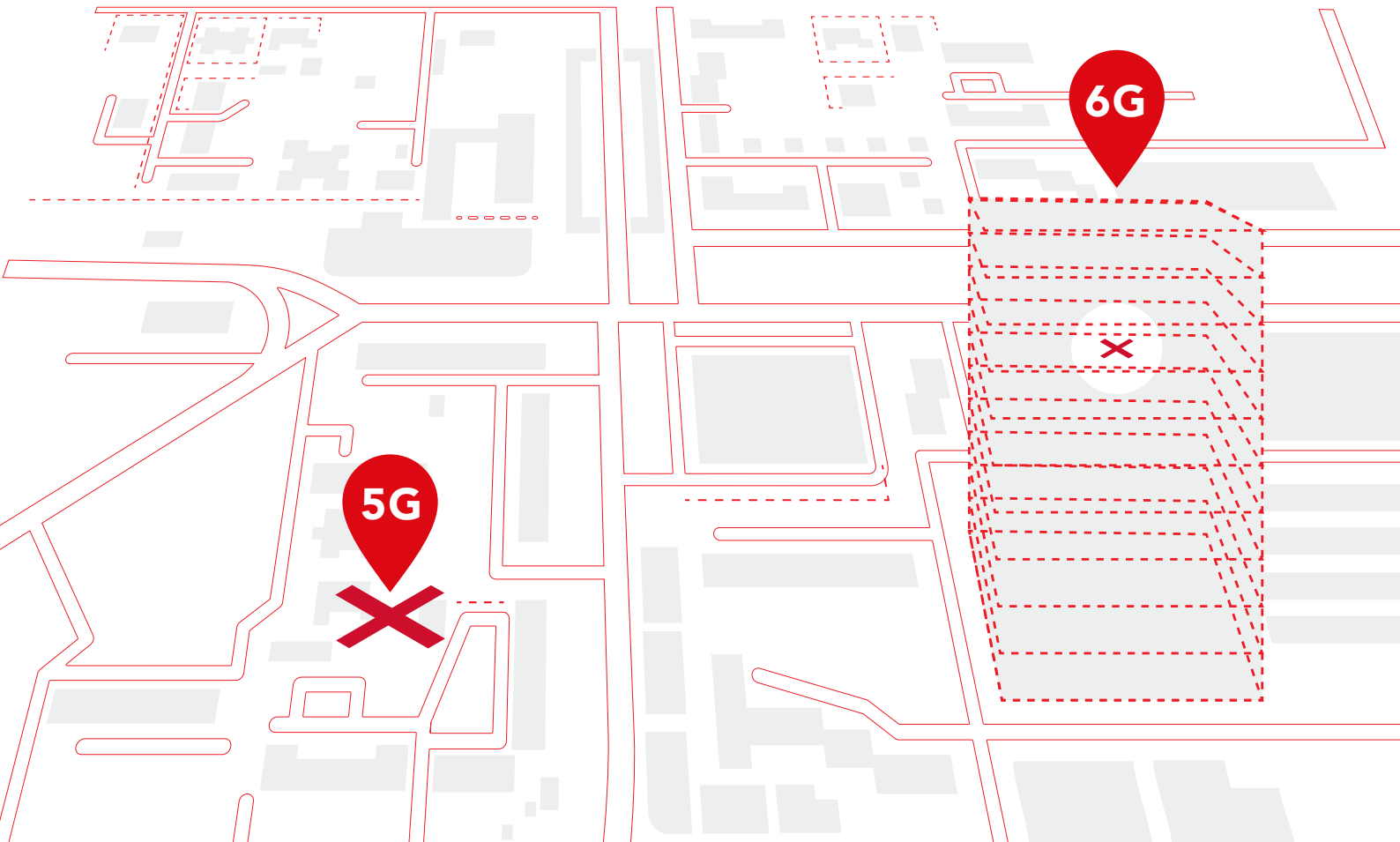

CONNECTED OBJECTS: FINDING GOOD COVERAGE

With more than 500 billion connected objects deployed by 2030, 6G will have to offer worldwide coverage. The multiplication of nanosatellite constellations dedicated to IoT will provide access to new services such as the monitoring of merchandise or livestock. To give communicating objects hybrid connectivity via a terrestrial radio connection and in relay, CEA-Leti is developing miniature antennas. Consuming less energy, low-frequency communication will improve autonomy, a critical aspect for IoT. Problem: the lower the communication frequency, the bigger the antenna has to be (around 37 cm at 400 MHz), making it difficult to fit an antenna to objects that are so small.

Miniaturization of antennas for IoT

Drawing on its expertise in design and integration of miniature antennas, CEA-Leti is attempting to reduce the size of IoT-dedicated antennas by 7.5 as part of a project jointly conducted with Kinésis, a French startup (with the support of the European Space Agency and the French National Space Agency).

Putting an end of dead zones

The Narrowband-IoT, one of the main communication protocols for IoT, is a low-consumption and long-range technology. Researchers are trying to use it with satellite links, making some minor adjustments to guarantee worldwide coverage, without dead zones. The Narrowband-IoT by satellite would be particularly justified in rural zones with low density and on the oceans, not covered by terrestrial base stations.



An initial 5 cm antenna prototype will be created in 2021 for applications operating in the 400 MHz band. We hope to go further by proposing IoT industry actors efficient micro-antennas of the order of one centimeter by 2025.



Christophe Delaveaud, research director and head of the antenna and propagation laboratory at CEA-Leti



A study on the Narrowband-IoT by satellite was conducted by CEA-Leti for the French national space agency (CNES) in 2021. "It showed by simulation that a constellation of satellites gravitating a few hundred kilometers above the Earth can connect with several million connected objects, with data rates of a few kilobits per second.



Vincent Berg, head of the IoT laboratory at CEA-Leti



Academic & Institutional Projects.

© HARALD RICHTER/ISTOCK - MONSIEUR/ADOBE STOCK

CEA-Leti coordinates or participates in several institutional projects, including projects funded by the French national research agency (ANR), the European Commission (H2020) or Carnot's network:

- Hexa-X
- Rise 6G
- Dedicat 6G
- 5GallStar
- Dragon
- CPS
- Beyond5
- Brave
- Criiot
- Next 5G
- FET Open Hermès

H2020

ANR

THINK TANK

CARNOT

FRANCE RELANCE

ECSEL

CONCLUSION



With the NEW-6G think tank, CEA-Leti has brought together all the actors of the value chain to define and develop future 6G standards and sustainability objectives.

Emilio Calvanese Strinati,
head of European 6G
projects and the NEW-6G
initiative at CEA-Leti



Like 5G, 6G will be based on a panel of radio, antenna, network, and computing technologies. The combination of these technologies, which are still at the candidate stage, remains unknown in 2021. It is certain that semi-conductors will be vehicles for numerous breakthroughs.

While the semi-conductor is ready, a few more years will be necessary before we have a clear idea of the future composition of 6G. One thing is certain: the best semi-conductor technologies must be combined with new transmission designs. CEA-Leti is ideally placed in this race given its expertise in systems, from circuit design to semiconductor technologies.

THANK YOU

This work has been partially supported by the European Commission's research and innovation programme (Horizon 2020), the French national research agency's (ANR) and Carnot's programs.

The Auvergne Rhône-Alpes region has co-financed CEA-Leti's state-of-the-art cleanroom equipment.

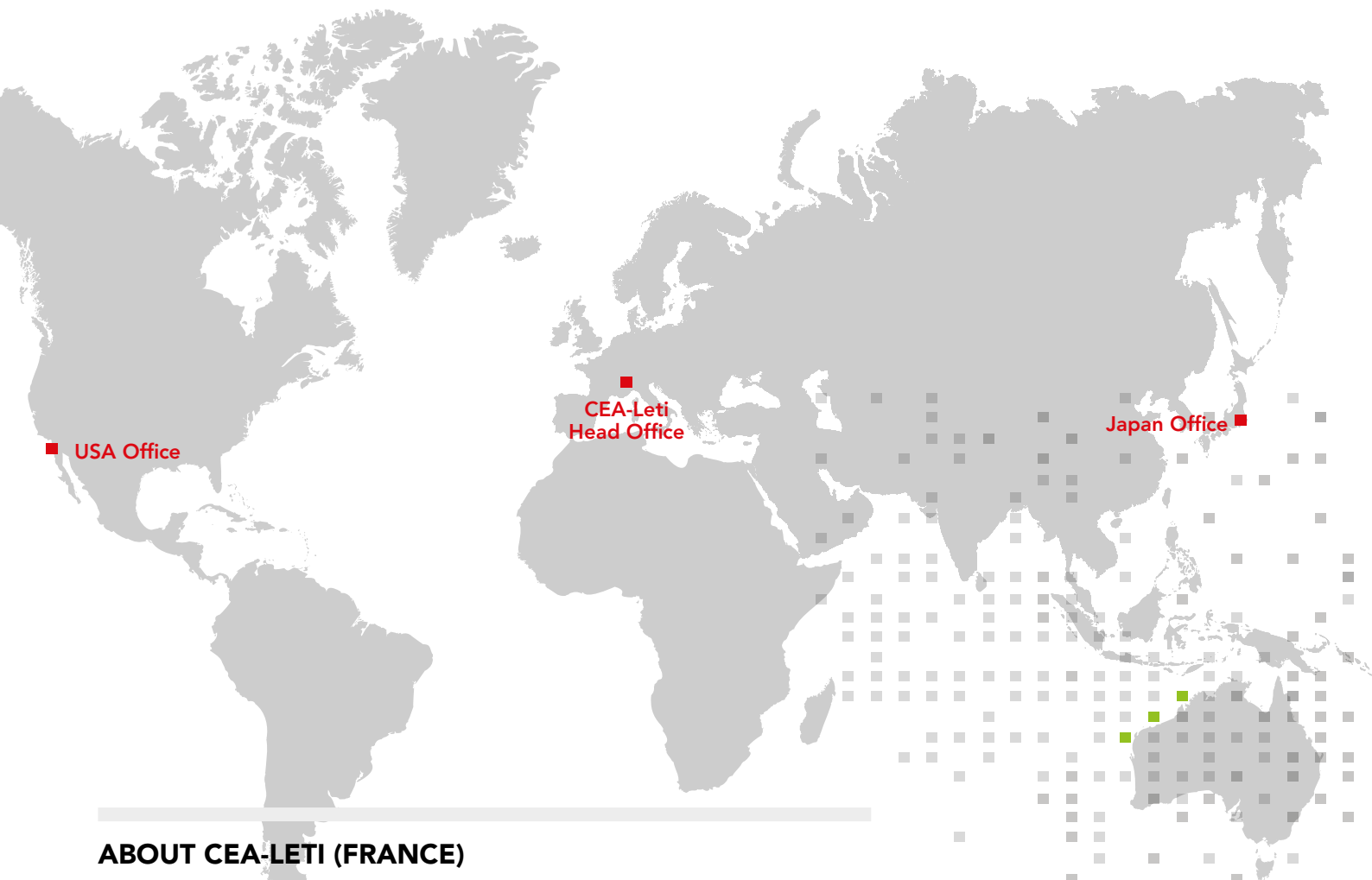

ABOUT CEA-LETI (FRANCE)

CEA-Leti, a technology research institute at CEA, is a global leader in miniaturization technologies enabling smart, energy-efficient and secure solutions for industry. Founded in 1967, CEA-Leti pioneers micro- & nanotechnologies, tailoring differentiating applicative solutions for global companies, SMEs and startups. CEA-Leti tackles critical challenges in healthcare, energy and digital migration. From sensors to data processing and computing solutions, CEA-Leti's multidisciplinary teams deliver solid expertise, leveraging world-class pre-industrialization facilities. With a staff of more than 1,900, a portfolio of 3,100 patents, 11,000 sq. meters of cleanroom space and a clear IP policy, the institute is based in Grenoble, France, and has offices in Silicon Valley and Tokyo. CEA-Leti has launched 70 startups and is a member of the Carnot Institutes network. Follow us on www.cea-leti.com and @CEA_Leti.

Technological expertise

CEA has a key role in transferring scientific knowledge and innovation from research to industry. This high-level technological research is carried out in particular in electronic and integrated systems, from microscale to nanoscale. It has a wide range of industrial applications in the fields of transport, health, safety and telecommunications, contributing to the creation of high-quality and competitive products.

For more information: www.cea.fr/english

CEA-Leti, technology research institute

Commissariat à l'énergie atomique et aux énergies alternatives
Minatec Campus | 17 avenue des Martyrs | 38054 Grenoble Cedex 9 | France
www.leti-cea.com

